

Brioso

BR 4111

安装说明

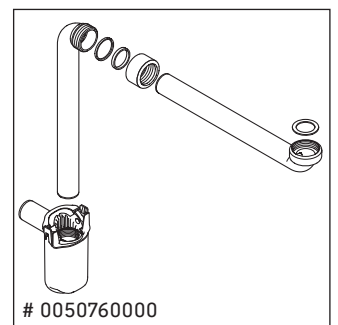
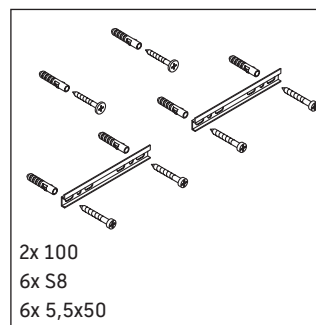
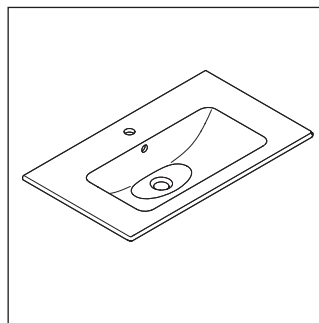
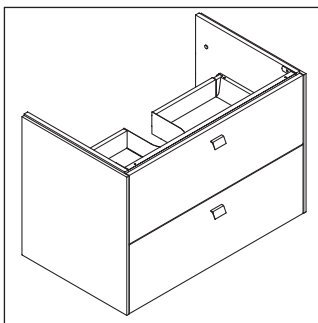
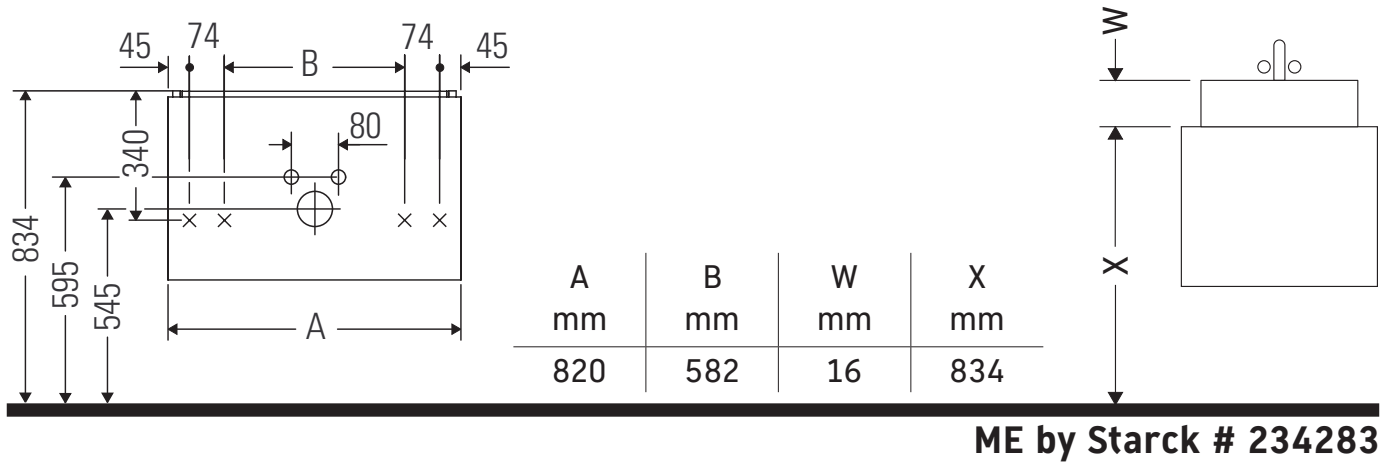

使用说明

卫浴家具系列产品在发货时符合现行有效的标准和规范，专为浴室而设计。必须避免被水直接淋湿，例如在淋浴时。

我们保留图示产品的技术改进和外观修改的权利。

